

## Safety switch Series SRF

Description **SRF-5/1/1-E0,25-L**

Article number **6075685102**

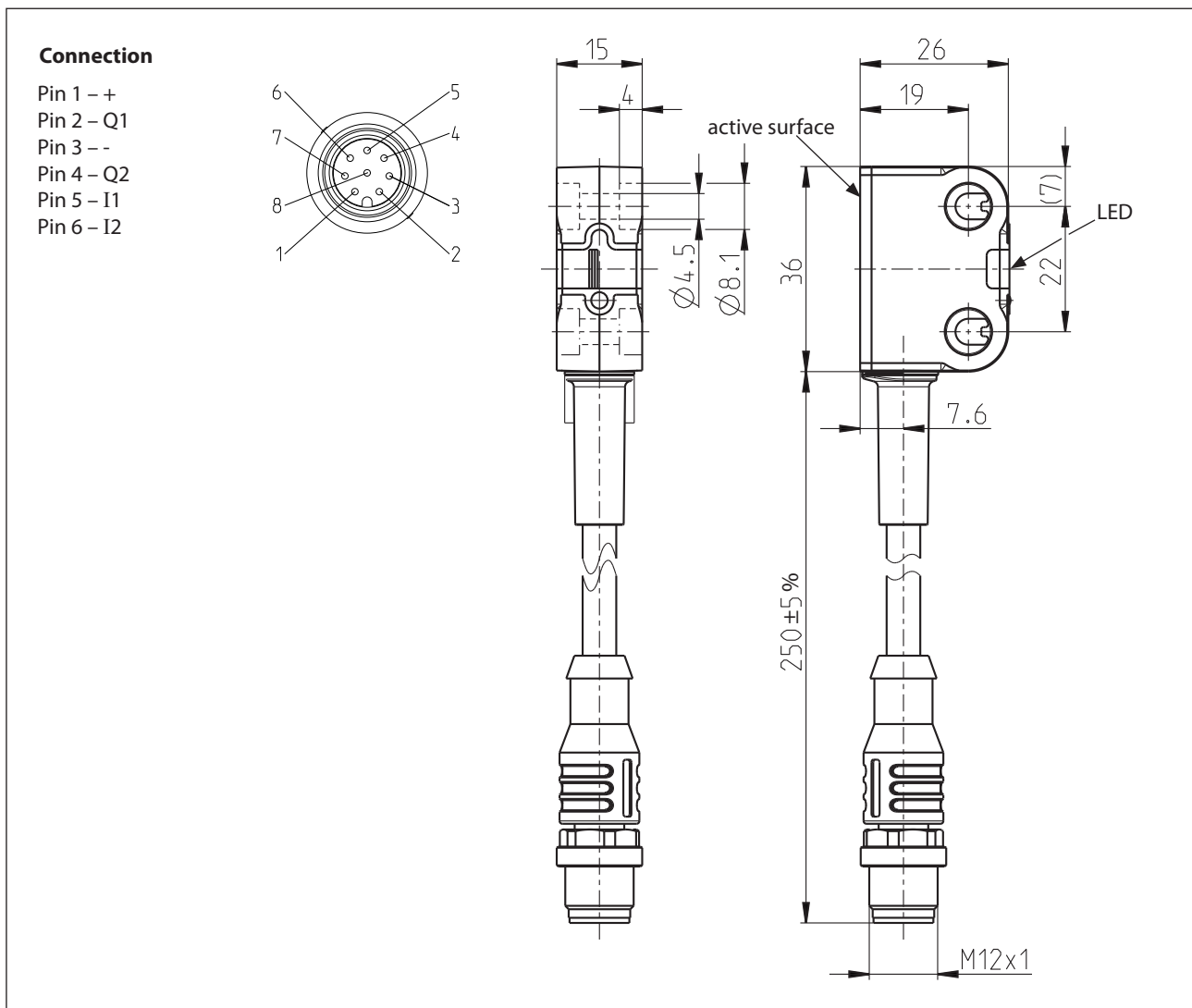

**Sensing distance** (Only in conjunction with actuator SRF-0.)

		min.	typ.	max.
Rated sensing distance	$S_n$		13 mm	
Assured sensing distance – On	$S_a$	10 mm		
Hysteresis	H		2 mm	
Assured sensing distance – Off	$S_{ar}$			25 mm

Electrical Data		
Rated operating voltage	$U_e$	24 V, Reverse polarity protection, +25 %, - 20 %
Rated insulation voltage	$U_i$	75 V DC
Rated impulse withstand voltage	$U_{imp}$	500 V
Rated conditional short circuit current		100 A
No-load current	$I_0$	≤ 50 mA
Transponder frequency		125 kHz
Repeatability operating frequency	R	0,1 x $S_n$ ≤ 1 Hz
Switch-off	$t_s$	max. 100 ms + 7 ms x following SRF
Time delay	$t_v$	max. 2 s
Electromagnetic interference		according to EN IEC 60947-5-3 and EN 61326-3-1
Outputs Q1,Q2		
Voltage level		according to Typ 3 EN 61131-2
Switching element function		pnp NO
Rated operating current	$I_e$	100 mA
Leakage current	$I_r$	≤ 1 mA DC
Switching elements		Sustained short-circuit and overload protection
Voltage drop	$U_d$	≤ 3 V
Type of short circuit protection		thermal / digital (clocking)
Utilization category		DC-13

Mechanical Data	
Enclosure	PA66 + PA6, red
Tension relief	TPE, black
Mounting	2 holes Ø 4,5 (for M4 screws)
Indication	1 x LED red / green operating state 1 x LED yellow Actuating state
Shock and Swing	acc. to EN IEC 60947-5-2
Ambient temperature	-25°C ... +70°C
Storage temperature	-25°C ... +70°C
Maximum relative humidity	93 % @ 40 °C without condensation
Altitude	≤ 2000 m NHN
Connection	0,25 m cable with plug connector M12 male, 8-pole
Type of protection	IP69
Protection class acc. to EN IEC 61558	III

Safety data		
Up to PL	e	acc. to EN ISO 13849-1
Category	4	
PFH <sub>D</sub>	6x10 <sup>-9</sup> 1/h	acc. to DIN EN 62061
SIL CL	3	
Service life	20 years	

Standards	
	ISO 12100, EN ISO 13849-1:2015, EN ISO 13849-2:2012,
	IEC 62061:2013, IEC 61508, IEC 62061: 2013, IEC 61508,
	ISO 60947-5-2, ISO 60947-5-3:2013, ISO 14119, EN 61326-3-1, EN 61131-2

EU-Conformity	
	according to directive 2006/42/EG (Safety-of-Machinery-Directive)
	according to directive 2011/65/EU (RoHS II)
	according to directive 2014/30/EU (EMV-Richtlinie)
	according to directive 2014/53/EU (RED)
	according to directive 2012/19/EU (EU-WEEE II) 

Approvals	
	TÜV Nord, cCSAus (class 2 Power source)
	FCC ID: 2ABA6SRF
	IC: 11535A-SRF

Notes	
The specified protection classification (IP code) applies only when an appropriate plug connector is used.	